

M2S1G64CBH4B5P / M2S2G64CB88B5N / M2S4G64CB8HB5N
1GB: 128M x 64 / 2GB: 256M x 64 / 4GB: 512M x 64
PC3-8500 / PC3-10600 / PC3-12800
Unbuffered DDR3 SO-DIMM



Based on DDR3-1066/1333/1600 128Mx16 (1GB) / 256Mx8 (2GB) / 256Mx8 (4GB) SDRAM B-Die

Features

•Performance:

Speed Sort	PC3-8500	PC3-10600	PC3-12800	Unit
	-BE	-CG	-DI	
DIMM CAS Latency	7	9	11	
fck – Clock Frequency	533	667	800	MHz
tck – Clock Cycle	1.875	1.5	1.25	ns
fDQ – DQ Burst Frequency	1066	1333	1600	Mbps

- 204-Pin Small Outline Dual In-Line Memory Module (SO-DIMM)
- 1GB: 128Mx64 Unbuffered DDR3 SO-DIMM based on 128Mx16 DDR3 SDRAM B-Die devices.
- 2GB: 256Mx64 Unbuffered DDR3 SO-DIMM based on 256Mx8 DDR3 SDRAM B-Die devices.
- 4GB: 512Mx64 Unbuffered DDR3 SO-DIMM based on 256Mx8 DDR3 SDRAM B-Die devices.
- Intended for 533MHz/667MHz/800MHz applications
- Inputs and outputs are SSTL-15 compatible
- $V_{DD} = V_{DDQ} = 1.5V \pm 0.075V$
- SDRAMs have 8 internal banks for concurrent operation
- Differential clock inputs
- Data is read or written on both clock edges
- DRAM DLL aligns DQ and DQS transitions with clock transitions.
- Address and control signals are fully synchronous to positive clock edge
- Programmable Operation:
 - DIMM \overline{CAS} Latency: 5, 6, 7, 8/PC3-8500; 5, 6, 7, 8, 9/PC3-10600; 5, 6, 7, 8, 9, 10, 11/PC3-12800
 - Burst Type: Sequential or Interleave
 - Burst Length: BC4, BL8
 - Operation: Burst Read and Write
- Two different termination values (Rtt_Nom & Rtt_WR)
- 14/10/1 (row/column/rank) Addressing for 1GB
- 15/10/1 (row/column/rank) Addressing for 2GB
- 15/10/2 (row/column/rank) Addressing for 4GB
- Extended operating temperature range
- Auto Self-Refresh option
- Serial Presence Detect
- Gold contacts
- 1GB: SDRAMs are in 96-ball BGA Package
- 2GB: SDRAMs are in 78-ball BGA Package
- 4GB: SDRAMs are in 78-ball BGA Package
- RoHS compliance and Halogen free

Description

M2S1G64CBH4B5P / M2S2G64CB88B5N / M2S4G64CB8HB5N are un-buffered 204-Pin Double Data Rate 3 (DDR3) Synchronous DRAM Small Outline Dual In-Line Memory Module (SO-DIMM), organized as one rank of 128Mx64 (1GB) and one rank of 256Mx64 (2GB) / 512Mx64 (4GB) high-speed memory array. Modules use four 128Mx16 (1GB) 96-ball BGA packaged devices and eight 256Mx8 (2GB) 78-ball BGA packaged devices and sixteen 256Mx8 (4GB) 78-ball BGA packaged devices. These DIMMs are manufactured using raw cards developed for broad industry use as reference designs. The use of these common design files minimizes electrical variation between suppliers. All Elixir DDR3 SODIMMs provide a high-performance, flexible 8-byte interface in a space-saving footprint.

The DIMM is intended for use in applications operating of 533MHz/667MHz/800MHz clock speeds and achieves high-speed data transfer rates of 1066Mbps/1333Mbps/1600Mbps. Prior to any access operation, the device \overline{CAS} latency and burst/length/operation type must be programmed into the DIMM by address inputs A0-A13 (1GB)/A0-A14 (2GB/4GB) and I/O inputs BA0–BA2 using the mode register set cycle.

The DIMM uses serial presence-detect implemented via a serial EEPROM using a standard IIC protocol. The first 128 bytes of SPD data are programmed and locked during module assembly. The remaining 128 bytes are available for use by the customer.

M2S1G64CBH4B5P / M2S2G64CB88B5N / M2S4G64CB8HB5N
1GB: 128M x 64 / 2GB: 256M x 64 / 4GB: 512M x 64
PC3-8500 / PC3-10600 / PC3-12800
Unbuffered DDR3 SO-DIMM



Ordering Information

Part Number	Speed			Organization	Power	Leads	Note
M2S1G64CBH4B5P-BE	DDR3-1066	PC3-8500	533MHz (1.875ns @ CL = 7)	128Mx64	1.5V	Gold	
M2S1G64CBH4B5P-CG	DDR3-1333	PC3-10600	667MHz (1.5ns @ CL = 9)				
M2S1G64CBH4B5P-DI	DDR3-1600	PC3-12800	800MHz(1.25ns @ CL=11)				
M2S2G64CB88B5N-BE	DDR3-1066	PC3-8500	533MHz (1.875ns @ CL = 7)	256Mx64			
M2S2G64CB88B5N-CG	DDR3-1333	PC3-10600	667MHz (1.5ns @ CL = 9)				
M2S2G64CB88B5N-DI	DDR3-1600	PC3-12800	800MHz(1.25ns @ CL=11)				
M2S4G64CB8HB5N-BE	DDR3-1066	PC3-8500	533MHz (1.875ns @ CL = 7)	512Mx64			
M2S4G64CB8HB5N-CG	DDR3-1333	PC3-10600	667MHz (1.5ns @ CL = 9)				
M2S4G64CB8HB5N-DI	DDR3-1600	PC3-12800	800MHz(1.25ns @ CL=11)				

Pin Description

Pin Name	Description	Pin Name	Description
CK0, CK1	Clock Inputs, positive line	DQ0-DQ63	Data input/output
$\overline{CK0}$, $\overline{CK1}$	Clock Inputs, negative line	DQS0-DQS7	Data strobes
CKE0, CKE1	Clock Enable	$\overline{DQS0}$ - $\overline{DQS7}$	Data strobes complement
\overline{RAS}	Row Address Strobe	DM0-DM7	Data Masks
\overline{CAS}	Column Address Strobe	\overline{EVENT}	Temperature event pin
\overline{WE}	Write Enable	\overline{RESET}	Reset pin
$\overline{S0}$, $\overline{S1}$	Chip Selects	V_{REFDQ} , V_{REFCA}	Input/Output Reference
A0-A9, A11, A13-A15	Address Inputs	V_{DDSPD}	SPD and Temp sensor power
A10/AP	Address Input/Auto-Precharge	SA0, SA1	Serial Presence Detect Address Inputs
A12/ \overline{BC}	Address Input/Burst Chop	V_{tt}	Termination voltage
BA0-BA2	SDRAM Bank Address Inputs	V_{SS}	Ground
ODT0, ODT1	Active termination control lines	V_{DD}	Core and I/O power
SCL	Serial Presence Detect Clock Input	NC	No Connect
SDA	Serial Presence Detect Data input/output		

Note: A14 is for 2GB and 4GB modules only.



DDR3 SDRAM Pin Assignment

Pin	Front	Pin	Back	Pin	Front	Pin	Back	Pin	Front	Pin	Back	Pin	Front	Pin	Back
1	V _{REFDQ}	2	V _{SS}	53	DQ19	54	V _{SS}	105	V _{DD}	106	V _{DD}	155	V _{SS}	156	V _{SS}
3	V _{SS}	4	DQ4	55	V _{SS}	56	DQ28	107	A10/AP	108	BA1	157	DQ42	158	DQ46
5	DQ0	6	DQ5	57	DQ24	58	DQ29	109	BA0	110	$\overline{\text{RAS}}$	159	DQ43	160	DQ47
7	DQ1	8	V _{SS}	59	DQ25	60	V _{SS}	111	V _{DD}	112	V _{DD}	161	V _{SS}	162	V _{SS}
9	V _{SS}	10	$\overline{\text{DQS0}}$	61	V _{SS}	62	$\overline{\text{DQS3}}$	113	$\overline{\text{WE}}$	114	$\overline{\text{S0}}$	163	DQ48	164	DQ52
11	DM0	12	DQS0	63	DM3	64	DQS3	115	$\overline{\text{CAS}}$	116	ODT0	165	DQ49	166	DQ53
13	V _{SS}	14	V _{SS}	65	V _{SS}	66	V _{SS}	117	V _{DD}	118	V _{DD}	167	V _{SS}	168	V _{SS}
15	DQ2	16	DQ6	67	DQ26	68	DQ30	119	A13/NC	120	ODT1	169	$\overline{\text{DQS6}}$	170	DM6
17	DQ3	18	DQ7	69	DQ27	70	DQ31	121	$\overline{\text{S1}}$	122	NC	171	DQS6	172	V _{SS}
19	V _{SS}	20	V _{SS}	71	V _{SS}	72	V _{SS}	123	V _{DD}	124	V _{DD}	173	V _{SS}	174	DQ54
21	DQ8	22	DQ12	73	CKE0	74	CKE1	125	NC	126	V _{REFCA}	175	DQ50	176	DQ55
23	DQ9	24	DQ13	75	V _{DD}	76	V _{DD}	127	V _{SS}	128	V _{SS}	177	DQ51	178	V _{SS}
25	V _{SS}	26	V _{SS}	77	NC	78	A15/NC	129	DQ32	130	DQ36	179	V _{SS}	180	DQ60
27	$\overline{\text{DQS1}}$	28	DM1	79	BA2	80	A14/NC	131	DQ33	132	DQ37	181	DQ56	182	DQ61
29	DQS1	30	$\overline{\text{RESET}}$	81	V _{DD}	82	V _{DD}	133	V _{SS}	134	V _{SS}	183	DQ57	184	V _{SS}
31	V _{SS}	32	V _{SS}	83	A12/ $\overline{\text{BC}}$	84	A11	135	$\overline{\text{DQS4}}$	136	DM4	185	V _{SS}	186	$\overline{\text{DQS7}}$
33	DQ10	34	DQ14	85	A9	86	A7	137	DQS4	138	V _{SS}	187	DM7	188	DQS7
35	DQ11	36	DQ15	87	V _{DD}	88	V _{DD}	139	V _{SS}	140	DQ38	189	V _{SS}	190	V _{SS}
37	V _{SS}	38	V _{SS}	89	A8	90	A6	141	DQ34	142	DQ39	191	DQ58	192	DQ62
39	DQ16	40	DQ20	91	A5	92	A4	143	DQ35	144	V _{SS}	193	DQ59	194	DQ63
41	DQ17	42	DQ21	93	V _{DD}	94	V _{DD}	145	V _{SS}	146	DQ44	195	V _{SS}	196	V _{SS}
43	V _{SS}	44	V _{SS}	95	A3	96	A2	147	DQ40	148	DQ45	197	SA0	198	$\overline{\text{EVENT}}$
45	$\overline{\text{DQS2}}$	46	DM2	97	A1	98	A0	149	DQ41	150	V _{SS}	199	V _{DDSPD}	200	SDA
47	DQS2	48	V _{SS}	99	V _{DD}	100	V _{DD}	151	V _{SS}	152	$\overline{\text{DQS5}}$	201	SA1	202	SCL
49	V _{SS}	50	DQ22	101	CK0	102	CK1	153	DM5	154	DQS5	203	V _{tt}	204	V _{tt}
51	DQ18	52	DQ23	103	$\overline{\text{CK0}}$	104	$\overline{\text{CK1}}$								

Note: A14 is for 2GB and 4GB modules only.

Input / Output Functional Description

Symbol	Type	Polarity	Function
CK0, CK1 CK0, CK1	Input	Cross point	The system clock inputs. All address and command lines are sampled on the cross point of the rising edge of CK and falling edge of CK. A Delay Locked Loop (DLL) circuit is driven from the clock inputs and output timing for read operations is synchronized to the input clock.
CKE0, CKE1	Input	Active High	Activates the DDR3 SDRAM CK signal when high and deactivates the CK signal when low. By deactivating the clocks, CKE low initiates the Power Down mode or the Self Refresh mode.
S0, S1	Input	Active Low	Enables the associated DDR3 SDRAM command decoder when low and disables the command decoder when high. When the command decoder is disabled, new commands are ignored but previous operations continue, Rank 0 is selected by S0; Rank 1 is selected by S1.
RAS, CAS, WE	Input	Active Low	When sampled at the positive rising edge of CK and falling edge of CK, signals RAS, CAS, WE define the operation to be executed by the SDRAM.
ODT0, ODT1	Input	Active High	Asserts on-die termination for DQ, DM, DQS, and DQS signals if enabled via the DDR3 SDRAM mode register.
DM0 – DM7	Input	Active High	The data write masks, associated with one data byte. In Write mode, DM operates as a byte mask by allowing input data to be written if it is low but blocks the write operation if it is high. In Read mode, DM lines have no effect.
DQS0 – DQS7 DQS0 – DQS7	I/O	Cross point	The data strobes, associated with one data byte, sourced with data transfers. In Write mode, the data strobe is sourced by the controller and is centered in the data window. In Read mode, the data strobe is sourced by the DDR3 SDRAM and is sent at the leading edge of the data window. DQS signals are complements, and timing is relative to the cross point of respective DQS and DQS. If the module is to be operated in single ended strobe mode, all DQS signals must be tied on the system board to VSS and DDR3 SDRAM mode registers programmed appropriately.
BA0, BA1, BA2	Input	-	Selects which DDR3 SDRAM internal bank of four or eight is activated.
A0 – A9 A10/AP A11 A12/BC A13 – A15	Input	-	During a Bank Activate command cycle, defines the row address when sampled at the cross point of the rising edge of CK and falling edge of CK. During a Read or Write command cycle, defines the column address when sampled at the cross point of the rising edge of CK and falling edge of CK. In addition to the column address, AP is used to invoke autoprecharge operation at the end of the burst read or write cycle. If AP is high, autoprecharge is selected and BA0-BAn defines the bank to be precharged. If AP is low, autoprecharge is disabled. During a Precharge command cycle, AP is used in conjunction with BA0-BAn to control which bank(s) to precharge. If AP is high, all banks will be precharged regardless of the state of BA0-BAn inputs. If AP is low, then BA0-BAn are used to define which bank to precharge.
DQ0 – DQ63	Input	-	Data Input/Output pins.
VDD, VDDSPD, VSS	Supply	-	Power supplies for core, I/O, Serial Presence Detect, Temp sensor, and ground for the module.
VREFDQ, VREFCA	Supply	-	Reference voltage for SSTL15 inputs
SDA	I/O	-	This is a bidirectional pin used to transfer data into or out of the SPD EEPROM and temp sensor. A resistor must be connected from the SDA bus line to VDDSPD on the system planar to act as a pull up.
SCL	Input	-	This signal is used to clock data into and out of the SPD EEPROM and Temp sensor.
SA0 – SA2	Input	-	Address pins used to select the Serial Presence Detect and Temp sensor base address.
EVENT	Output	-	The EVENT pin is reserved for use to flag critical module temperature.
RESET	Input	-	This signal resets the DDR3 SDRAM
ZQ	Supply	-	Reference pin for ZQ calibration

Functional Block Diagram

[1GB – 1 Rank, 128Mx16 DDR3 SDRAMs]

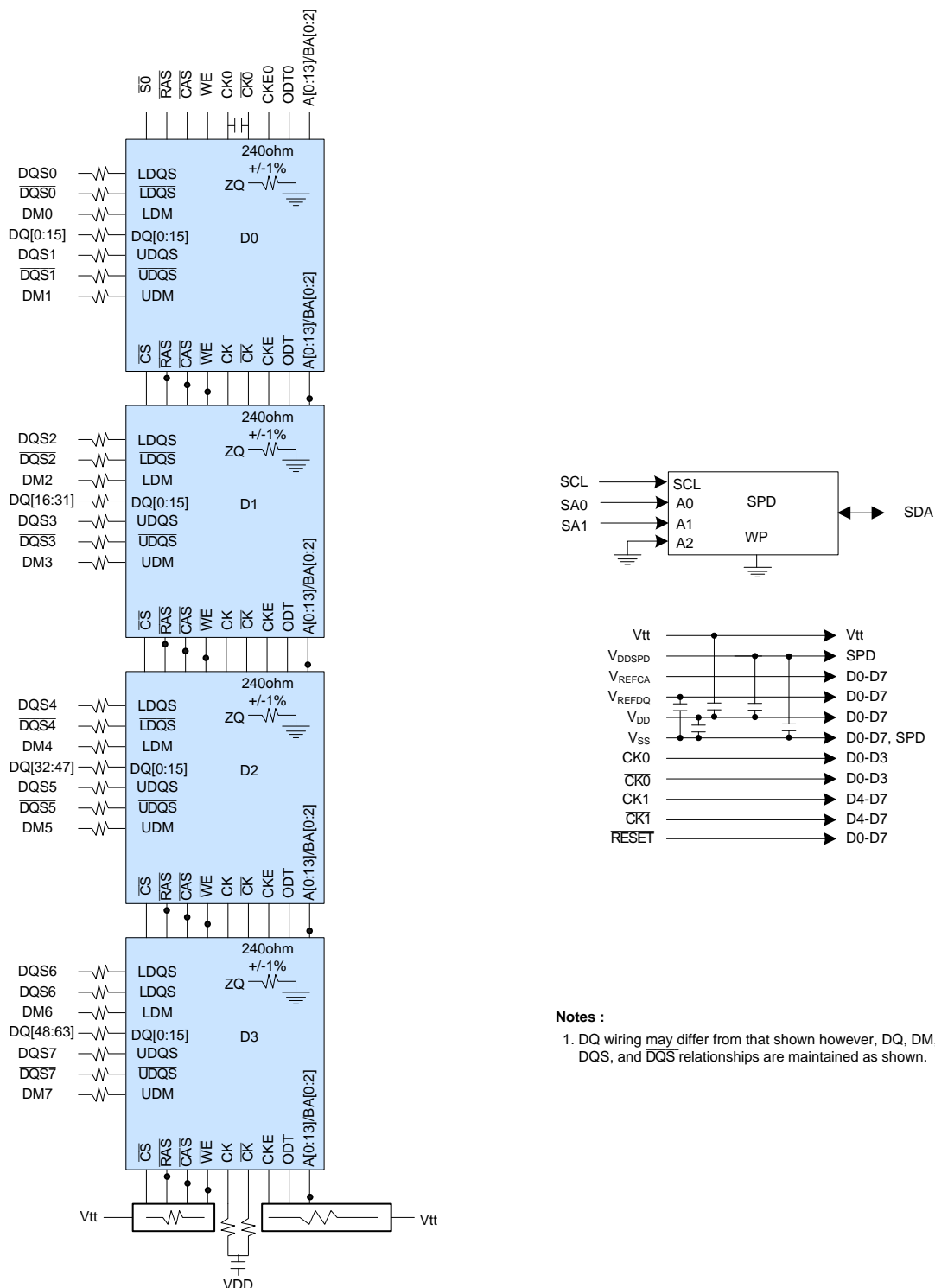

M2S1G64CBH4B5P / M2S2G64CB88B5N / M2S4G64CB8HB5N
1GB: 128M x 64 / 2GB: 256M x 64 / 4GB: 512M x 64
PC3-8500 / PC3-10600 / PC3-12800
Unbuffered DDR3 SO-DIMM



Functional Block Diagram

[2GB – 1 Rank, 256Mx8 DDR3 SDRAMs]

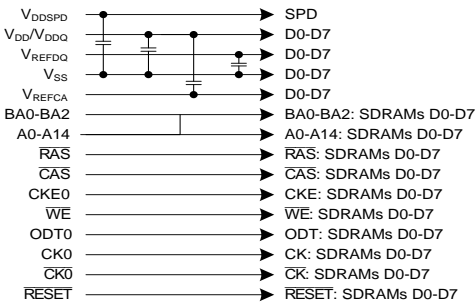
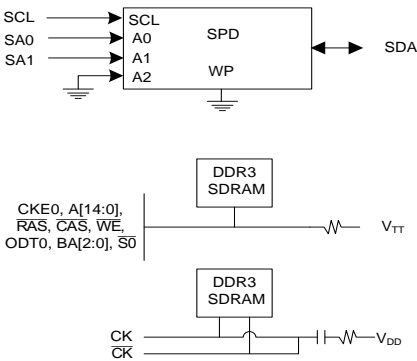
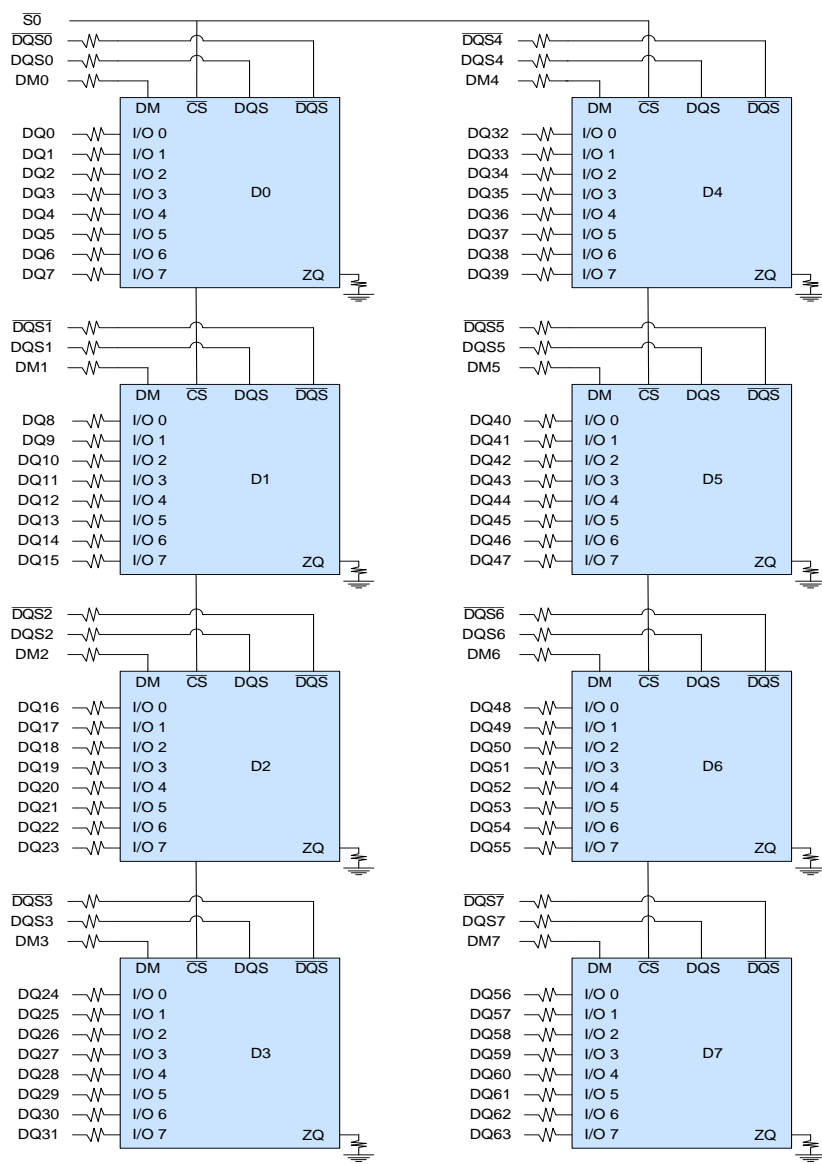

- Notes :**
1. DQ-to-I/O wiring is shown as recommended but may be changed.
 2. DQ/DQS/DQS/ODT/DM/CKE/S relationships must be maintained as shown.
 3. For each DRAM, a unique ZQ resistor is connected to ground. The ZQ resistor is 240Ω ±1%.
 4. One SPD exists per module.

Functional Block Diagram

[4GB – 2 Ranks, 256Mx8 DDR3 SDRAMs]

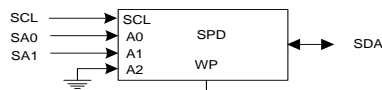
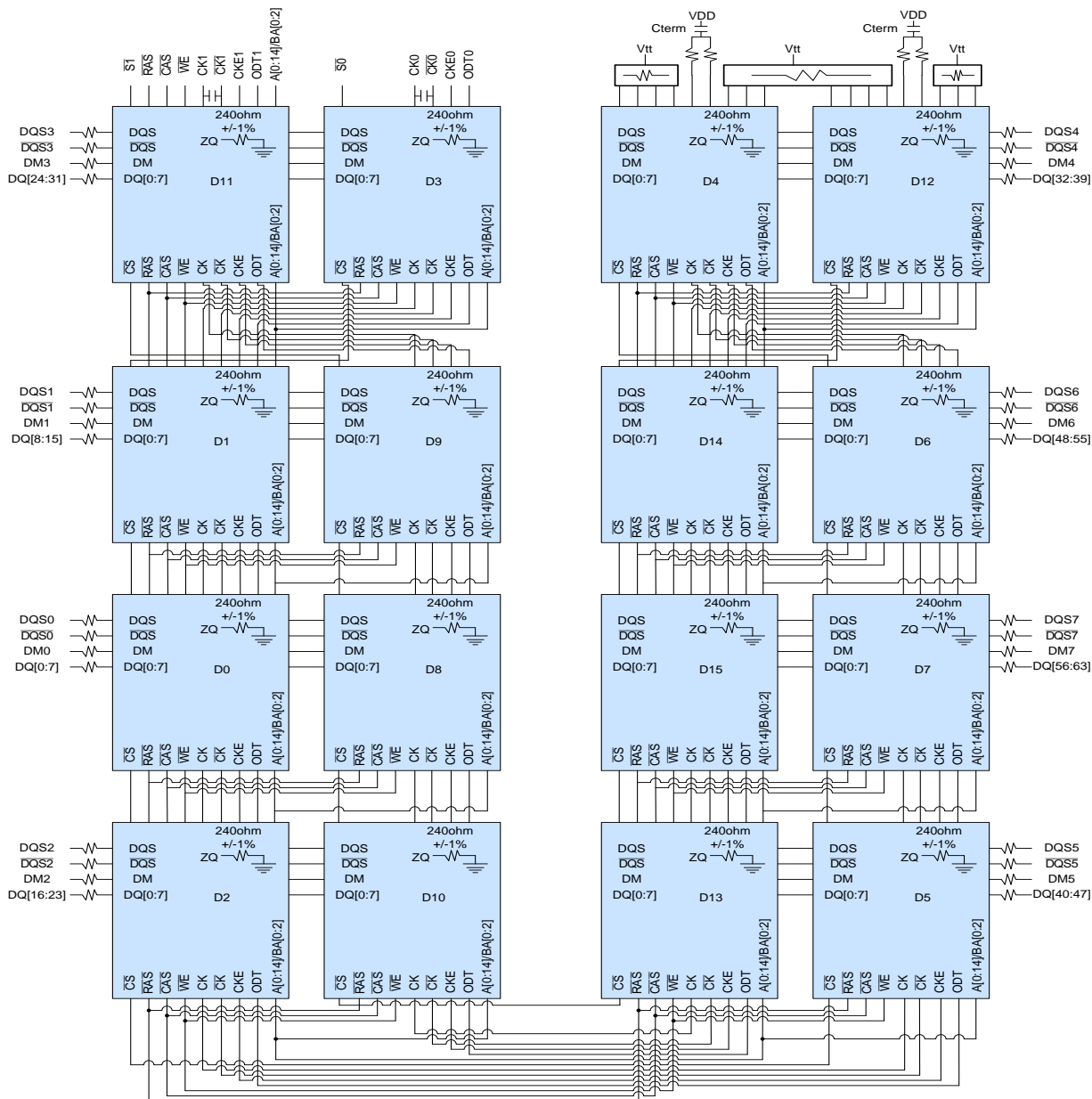

Notes :
 1. DQ wiring may differ from that shown however, DQ, DM, DQS, and DQS relationships are maintained as shown.

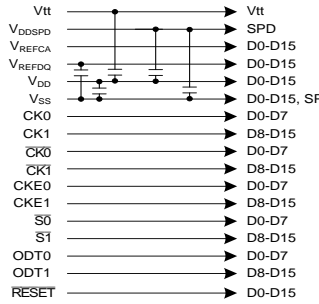

M2S1G64CBH4B5P / M2S2G64CB88B5N / M2S4G64CB8HB5N
1GB: 128M x 64 / 2GB: 256M x 64 / 4GB: 512M x 64
PC3-8500 / PC3-10600 / PC3-12800
Unbuffered DDR3 SO-DIMM



Serial Presence Detect [1GB – 1 Rank, 128Mx16 DDR3 SDRAMs]				
Byte	Description	SPD Data Entry (Hex.)		
		-BE	-CG	-DI
0	CRC range, EEPROM bytes, bytes used	92	92	92
1	SPD revision	10	10	10
2	DRAM device type	0B	0B	0B
3	Module type (form factor)	03	03	03
4	SDRAM Device density and banks	03	03	03
5	SDRAM device row and column count	11	11	11
6	Reserved	00	00	00
7	Module ranks and device DQ count	02	02	02
8	ECC tag and module memory Bus width	03	03	03
9	Fine timebase dividend/divisor (in ps)	52	52	52
10	Medium timebase dividend	01	01	01
11	Medium timebase divisor	08	08	08
12	Minimum SDRAM cycle time (tCKmin)	0F	0C	0A
13	Reserved	00	00	00
14	CAS latencies supported	1E	3E	FE
15	CAS latencies supported	00	00	00
16	Minimum CAS latency time (tAmin)	69	69	69
17	Minimum write recovery time (tWRmin)	78	78	78
18	Minimum CAS-to-CAS delay (tRCDmin)	69	69	69
19	Minimum Row Active to Row Active delay (tRRDmin)	50	3C	3C
20	Minimum row Precharge delay (tRPmin)	69	69	69
21	Upper nibble for tRAS and tRC	11	11	11
22	Minimum Active-to-Precharge delay (tRASmin)	2C	20	18
23	Minimum Active-to-Active/Refresh delay (tRCmin)	95	89	81
24	Minimum refresh recovery delay (tRFCmin) LSB	00	00	00
25	Minimum refresh recovery delay (tRFCmin) MSB	05	05	05
26	Minimum internal Write-to-Read command delay (tWTRmin)	3C	3C	3C
27	Minimum internal Read-to-Precharge command delay (tRTPmin)	3C	3C	3C
28	Minimum four active window delay (tFAWmin) LSB	01	01	01
29	Minimum four active window delay (tFAWmin) MSB	90	68	40
30	SDRAM device output drivers supported	83	83	83
31	SDRAM device thermal and refresh options	05	05	05
32	Module Thermal Sensor	00	00	00
33	SDRAM Device Type	00	00	00
60	Module height (nominal)	0F	0F	0F
61	Module thickness (Max)	01	01	01
62	Raw Card ID reference	22	22	22
63	DRAM address mapping edge connector	00	00	00
117	Module manufacture ID	83	83	83
118	Module manufacture ID	0B	0B	0B
119-121	Module manufacturer Information	--	--	--
126	CRC	--	--	--
127	CRC	--	--	--
128-145	Module part number	--	--	--
146	Module die revision	--	--	--
147	Module PCB revision	--	--	--
150-175	Manufacturer reserved	--	--	--
176-255	Customer reserved	--	--	--

M2S1G64CBH4B5P / M2S2G64CB88B5N / M2S4G64CB8HB5N
1GB: 128M x 64 / 2GB: 256M x 64 / 4GB: 512M x 64
PC3-8500 / PC3-10600 / PC3-12800
Unbuffered DDR3 SO-DIMM



Serial Presence Detect [2GB – 1 Rank, 256Mx8 DDR3 SDRAMs]				
Byte	Description	Serial PD Data Entry (Hex.)		
		-BE	-CG	-DI
0	CRC range, EEPROM bytes, bytes used	92	92	92
1	SPD revision	10	10	10
2	DRAM device type	0B	0B	0B
3	Module type (form factor)	03	03	03
4	SDRAM Device density and banks	03	03	03
5	SDRAM device row and column count	19	19	19
6	Reserved	00	00	00
7	Module ranks and device DQ count	01	01	01
8	ECC tag and module memory Bus width	03	03	03
9	Fine timebase dividend/divisor (in ps)	52	52	52
10	Medium timebase dividend	01	01	01
11	Medium timebase divisor	08	08	08
12	Minimum SDRAM cycle time (tCKmin)	0F	0C	0A
13	Reserved	00	00	00
14	CAS latencies supported	1E	3E	FE
15	CAS latencies supported	00	00	00
16	Minimum CAS latency time (tAAmin)	69	69	69
17	Minimum write recovery time (tWRmin)	78	78	78
18	Minimum CAS-to-CAS delay (tRCDmin)	69	69	69
19	Minimum Row Active to Row Active delay (tRRDmin)	3C	30	30
20	Minimum row Precharge delay (tRPmin)	69	69	69
21	Upper nibble for tRAS and tRC	11	11	11
22	Minimum Active-to-Precharge delay (tRASmin)	2C	20	18
23	Minimum Active-to-Active/Refresh delay (tRCmin)	95	89	81
24	Minimum refresh recovery delay (tRFCmin) LSB	00	00	00
25	Minimum refresh recovery delay (tRFCmin) MSB	05	05	05
26	Minimum internal Write-to-Read command delay (tWTRmin)	3C	3C	3C
27	Minimum internal Read-to-Precharge command delay (tRTPmin)	3C	3C	3C
28	Minimum four active window delay (tFAWmin) LSB	01	00	00
29	Minimum four active window delay (tFAWmin) MSB	2C	F0	F0
30	SDRAM device output drivers supported	83	83	83
31	SDRAM device thermal and refresh options	05	05	05
32	Module Thermal Sensor	00	00	00
33	SDRAM Device Type	00	00	00
60	Module height (nominal)	0F	0F	0F
61	Module thickness (Max)	11	11	11
62	Raw Card ID reference	41	41	41
63	DRAM address mapping edge connector	00	00	00
117	Module manufacture ID	83	83	83
118	Module manufacture ID	0B	0B	0B
119-121	Module manufacturer Information	--	--	--
126	CRC	--	--	--
127	CRC	--	--	--
128-145	Module part number	--	--	--
146	Module die revision	--	--	--
147	Module PCB revision	--	--	--
150-175	Manufacturer reserved	--	--	--
176-255	Customer reserved	--	--	--

M2S1G64CBH4B5P / M2S2G64CB88B5N / M2S4G64CB8HB5N
1GB: 128M x 64 / 2GB: 256M x 64 / 4GB: 512M x 64
PC3-8500 / PC3-10600 / PC3-12800
Unbuffered DDR3 SO-DIMM



Serial Presence Detect [4GB – 2 Ranks, 256Mx8 DDR3 SDRAMs]				
Byte	Description	Serial PD Data Entry (Hex.)		
		-BE	-CG	-DI
0	CRC range, EEPROM bytes, bytes used	92	92	92
1	SPD revision	10	10	10
2	DRAM device type	0B	0B	0B
3	Module type (form factor)	03	03	03
4	SDRAM Device density and banks	03	03	03
5	SDRAM device row and column count	19	19	19
6	Reserved	00	00	00
7	Module ranks and device DQ count	09	09	09
8	ECC tag and module memory Bus width	03	03	03
9	Fine timebase dividend/divisor (in ps)	52	52	52
10	Medium timebase dividend	01	01	01
11	Medium timebase divisor	08	08	08
12	Minimum SDRAM cycle time (tCKmin)	0F	0C	0A
13	Reserved	00	00	00
14	CAS latencies supported	1E	3E	FE
15	CAS latencies supported	00	00	00
16	Minimum CAS latency time (tAAmin)	69	69	69
17	Minimum write recovery time (tWRmin)	78	78	78
18	Minimum CAS-to-CAS delay (tRCDmin)	69	69	69
19	Minimum Row Active to Row Active delay (tRRDmin)	3C	30	30
20	Minimum row Precharge delay (tRPmin)	69	69	69
21	Upper nibble for tRAS and tRC	11	11	11
22	Minimum Active-to-Precharge delay (tRASmin)	2C	20	18
23	Minimum Active-to-Active/Refresh delay (tRCmin)	95	89	81
24	Minimum refresh recovery delay (tRFCmin) LSB	00	00	00
25	Minimum refresh recovery delay (tRFCmin) MSB	05	05	05
26	Minimum internal Write-to-Read command delay (tWTRmin)	3C	3C	3C
27	Minimum internal Read-to-Precharge command delay (tRTPmin)	3C	3C	3C
28	Minimum four active window delay (tFAWmin) LSB	01	00	00
29	Minimum four active window delay (tFAWmin) MSB	2C	F0	F0
30	SDRAM device output drivers supported	83	83	83
31	SDRAM device thermal and refresh options	05	05	05
32	Module Thermal Sensor	00	00	00
33	SDRAM Device Type	00	00	00
60	Module height (nominal)	0F	0F	0F
61	Module thickness (Max)	11	11	11
62	Raw Card ID reference	45	45	45
63	DRAM address mapping edge connector	00	00	00
117	Module manufacture ID	83	83	83
118	Module manufacture ID	0B	0B	0B
119-121	Module manufacturer Information	--	--	--
126	CRC	--	--	--
127	CRC	--	--	--
128-145	Module part number	--	--	--
146	Module die revision	--	--	--
147	Module PCB revision	--	--	--
150-175	Manufacturer reserved	--	--	--
176-255	Customer reserved	--	--	--

Environmental Requirements

Symbol	Parameter	Rating	Units
T _{OPR}	Operating Temperature (ambient)	0 to 85	°C
T _{STG}	Storage Temperature	-55 to +100	°C

Note: Stress greater than those listed may cause permanent damage to the device. This is a stress rating only, and device functional operation at or above the conditions indicated is not implied. Exposure to absolute maximum rating conditions for extended periods may affect reliability.

Absolute Maximum DC Ratings

Symbol	Parameter	Rating	Units	Note
V _{DD}	Voltage on VDD pins relative to Vss	-0.4 V ~ 1.975 V	V	1, 3
V _{DDQ}	Voltage on VDDQ pins relative to Vss	-0.4 V ~ 1.975 V	V	1, 3
V _{IN} , V _{OUT}	Voltage on I/O pins relative to Vss	-0.4 V ~ 1.975 V	V	1
T _{STG}	Storage Temperature	-55 to +100	°C	1, 2

Note:

- Stresses greater than those listed under "Absolute Maximum Ratings" may cause permanent damage to the device. This is a stress rating only and functional operation of the device at these or any other conditions above those indicated in the operational sections of this specification is not implied. Exposure to absolute maximum rating conditions for extended periods may affect reliability
- Storage Temperature is the case surface temperature on the center/top side of the DRAM. For the measurement conditions, please refer to JESD51-2 standard.
- VDD and VDDQ must be within 300 mV of each other at all times; and VREF must be not greater

Operating temperature Conditions

Symbol	Parameter	Rating	Units	Note
T _{OPER}	Normal Operating Temperature Range	0 to 85	°C	1, 2
	Extended Temperature Range	85 to 95	°C	1, 3

Note:

- Operating Temperature TOPER is the case surface temperature on the center / top side of the DRAM. For measurement conditions, please refer to the JEDEC document JESD51-2.
- The Normal Temperature Range specifies the temperatures where all DRAM specifications will be supported. During operation, the DRAM case temperature must be maintained between 0 to 85 °C under all operating conditions
- Some applications require operation of the DRAM in the Extended Temperature Range between 85 °C and 95 °C case temperature. Full specifications are supported in this range, but the following additional conditions apply:
 - Refresh commands must be doubled in frequency, therefore reducing the Refresh interval tREFI to 3.9 μs. It is also possible to specify a component with 1X refresh (tREFI to 7.8 μs) in the Extended Temperature Range. Please refer to supplier data sheet and/or the DIMM SPD for option availability.
 - If Self-Refresh operation is required in the Extended Temperature Range, then it is mandatory to either use the Manual Self-Refresh mode with Extended Temperature Range capability (MR2 A6 = 0b and MR2 A7 = 1b) or enable the optional Auto Self-Refresh mode (MR2 A6 = 1b and MR2 A7 = 0b). Please refer to the supplier data sheet and/or the DIMM SPD for Auto Self-Refresh option availability, Extended Temperature Range support and tREFI requirements in the Extended Temperature Range.

DC Electrical Characteristics and Operating Conditions

Symbol	Parameter	Min	Typ	Max	Units	Notes
V _{DD}	Supply Voltage	1.425	1.5	1.575	V	1,2
V _{DDQ}	Output Supply Voltage	1.425	1.5	1.575	V	1,2

Note:

- Under all conditions VDDQ must be less than or equal to VDD.
- VDDQ tracks with VDD. AC parameters are measured with VDD and VDDQ tied together.

Single-Ended AC and DC Input Levels for Command and Address

Symbol	Parameter	DDR3-1066 (-BE)		DDR3-1333 (-CG)		DDR3-1600(-DI)		Units	Note
		Min.	Max.	Min.	Max.	Min.	Max.		
VIH.CA(DC)	DC Input Logic High	Vref + 0.100	VDD	Vref + 0.100	VDD	Vref + 0.100	VDD	V	1
VIL.CA(DC)	DC Input Logic Low	VSS	Vref - 0.100	VSS	Vref - 0.100	VSS	Vref - 0.100	V	1
VIH.CA(AC)	AC Input Logic High	Vref + 0.175	Note 2	Vref + 0.175	Note 2	Vref + 0.175	Note 2	V	1, 2
VIL.CA(AC)	AC Input Logic Low	Note 2	Vref - 0.175	Note 2	Vref - 0.175	Note 2	Vref - 0.175	V	1, 2
VIH.CA(AC150)	AC Input Logic High	Vref + 0.15	Note 2	Vref + 0.15	Note 2	Vref + 0.15	Note 2	V	1, 2
VIL.CA(AC150)	AC Input Logic Low	Note 2	Vref - 0.15	Note 2	Vref - 0.15	Note 2	Vref - 0.15	V	1, 2
V _{RefCA(DC)}	Reference Voltage for ADD, CMD Inputs	0.49 x VDD	0.51 x VDD	0.49 x VDD	0.51 x VDD	0.49 x VDD	0.51 x VDD	V	3, 4

Note:

1. For input only pins except RESET#. Vref = VrefCA(DC).
2. See "Overshoot and Undershoot Specifications" in the device datasheet.
3. The ac peak noise on VRef may not allow VRef to deviate from VRefDQ(DC) by more than +/-1% VDD (for reference: approx. +/- 15 mV).
4. For reference: approx. VDD/2 +/- 15 mV.

Single-Ended AC and DC Input Levels for DQ and DM

Symbol	Parameter	DDR3-1066 (-BE)		DDR3-1333 (-CG)		DDR3-1600(-DI)		Units	Note
		Min.	Max.	Min.	Max.	Min.	Max.		
VIH.DQ(DC)	DC Input Logic High	Vref + 0.100	VDD	Vref + 0.100	VDD	Vref + 0.100	VDD	V	1
VIL.DQ(DC)	DC Input Logic Low	VSS	Vref - 0.100	VSS	Vref - 0.100	VSS	Vref - 0.100	V	1
VIH.DQ(AC)	AC Input Logic High	Vref + 0.175	Note 2	Vref + 0.15	Note 2	Vref + 0.15	Note 2	V	1, 2, 5
VIL.DQ(AC)	AC Input Logic Low	Note 2	Vref - 0.175	Note 2	Vref - 0.15	Note 2	Vref - 0.15	V	1, 2, 5
V _{RefDQ(DC)}	Reference Voltage for DQ, DM Inputs	0.49 x VDD	0.51 x VDD	0.49 x VDD	0.51 x VDD	0.49 x VDD	0.51 x VDD	V	3, 4

Note:

1. For input only pins except RESET#. Vref = VrefDQ(DC).
2. See "Overshoot and Undershoot Specifications" in the device datasheet.
3. The ac peak noise on VRef may not allow VRef to deviate from VRefDQ(DC) by more than +/-1% VDD (for reference: approx. +/- 15 mV).
4. For reference: approx. VDD/2 +/- 15 mV.
5. Single-ended swing requirement for DQS, DQS# is 350 mV (peak to peak). Differential swing requirement for DQS - DQS# is 700 mV (peak to peak).

M2S1G64CBH4B5P / M2S2G64CB88B5N / M2S4G64CB8HB5N
1GB: 128M x 64 / 2GB: 256M x 64 / 4GB: 512M x 64
PC3-8500 / PC3-10600 / PC3-12800
Unbuffered DDR3 SO-DIMM



Operating, Standby, and Refresh Currents

T_{CASE} = 0 °C ~ 85 °C; V_{DDQ} = V_{DD} = 1.5V ± 0.075V [1GB – 1 Rank, 128Mx16 DDR3 SDRAMs]

Symbol	Parameter/Condition	PC3-8500	PC3-10600	PC3-12800	Unit
		(-BE)	(-CG)	(-DI)	
IDD0	Operating One Bank Active-Precharge Current	396	440	484	mA
IDD1	Operating One Bank Active-Read-Precharge Current	550	572	594	mA
IDD2P0	Precharge Power-Down Current Slow Exit	53	53	53	mA
IDD2P1	Precharge Power-Down Current Fast Exit	132	154	176	mA
IDD2Q	Precharge Quiet Standby Current	132	154	176	mA
IDD2N	Precharge Standby Current	141	163	185	mA
IDD3P	Active Power-Down Current	154	176	198	mA
IDD3N	Active Standby Current	132	176	198	mA
IDD4R	Operating Burst Read Current	880	1078	1188	mA
IDD4W	Operating Burst Write Current	924	1122	1232	mA
IDD5B	Burst Refresh Current	836	880	946	mA
IDD6	Self Refresh Current: Normal Temperature Range	53	53	53	mA
IDD7	Operating Bank Interleave Read Current	1650	1870	2090	mA

T_{CASE} = 0 °C ~ 85 °C; V_{DDQ} = V_{DD} = 1.5V ± 0.075V [2GB – 1 Rank, 256Mx8 DDR3 SDRAMs]

Symbol	Parameter/Condition	PC3-8500	PC3-10600	PC3-12800	Unit
		(-BE)	(-CG)	(-DI)	
IDD0	Operating One Bank Active-Precharge Current	660	748	836	mA
IDD1	Operating One Bank Active-Read-Precharge Current	836	880	924	mA
IDD2P0	Precharge Power-Down Current Slow Exit	106	106	106	mA
IDD2P1	Precharge Power-Down Current Fast Exit	220	264	308	mA
IDD2Q	Precharge Quiet Standby Current	264	308	352	mA
IDD2N	Precharge Standby Current	282	326	370	mA
IDD3P	Active Power-Down Current	264	308	352	mA
IDD3N	Active Standby Current	264	352	396	mA
IDD4R	Operating Burst Read Current	1232	1452	1584	mA
IDD4W	Operating Burst Write Current	1276	1452	1628	mA
IDD5B	Burst Refresh Current	1672	1760	1892	mA
IDD6	Self Refresh Current: Normal Temperature Range	106	106	106	mA
IDD7	Operating Bank Interleave Read Current	2948	3388	3828	mA

T_{CASE} = 0 °C ~ 85 °C; V_{DDQ} = V_{DD} = 1.5V ± 0.075V [4GB – 2 Ranks, 256Mx8 DDR3 SDRAMs]

Symbol	Parameter/Condition	PC3-8500	PC3-10600	PC3-12800	Unit
		(-BE)	(-CG)	(-DI)	
IDD0	Operating One Bank Active-Precharge Current	942	1074	1206	mA
IDD1	Operating One Bank Active-Read-Precharge Current	1118	1206	1294	mA
IDD2P0	Precharge Power-Down Current Slow Exit	211	211	211	mA
IDD2P1	Precharge Power-Down Current Fast Exit	440	528	616	mA
IDD2Q	Precharge Quiet Standby Current	528	616	704	mA
IDD2N	Precharge Standby Current	563	651	739	mA
IDD3P	Active Power-Down Current	528	616	704	mA
IDD3N	Active Standby Current	546	678	766	mA
IDD4R	Operating Burst Read Current	1514	1778	1954	mA
IDD4W	Operating Burst Write Current	1558	1778	1998	mA
IDD5B	Burst Refresh Current	1954	2086	2262	mA
IDD6	Self Refresh Current: Normal Temperature Range	211	211	211	mA
IDD7	Operating Bank Interleave Read Current	3230	3714	4198	mA



Standard Speed Bins

DDR3-1066MHz

Speed Bin			DDR3-1066				Unit
CL-nRCD-nRP			7-7-7 (-BE)		8-8-8 (-BF)		
Parameter	Symbol		Min	Max	Min	Max.	
Internal read command to first data	tAA		13.125	20.000	15.000	20.000	ns
ACT to internal read or write delay time	tRCD		13.125	-	15.000	-	ns
PRE command period	tRP		13.125	-	15.000	-	ns
ACT to ACT or REF command period	tRC		50.625	-	52.500	-	ns
ACT to PRE command period	tRAS		37.500	9*tREFI	37.500	9*tREFI	ns
CL=5	CWL=5	tCK(AVG)	3.000	3.300	3.000	3.300	ns
	CWL=6	tCK(AVG)	Reserved		Reserved		ns
CL=6	CWL=5	tCK(AVG)	2.500	3.300	2.500	3.300	ns
	CWL=6	tCK(AVG)	Reserved		Reserved		ns
CL=7	CWL=5	tCK(AVG)	Reserved		Reserved		ns
	CWL=6	tCK(AVG)	1.875	<2.5	Reserved		ns
CL=8	CWL=5	tCK(AVG)	Reserved		Reserved		ns
	CWL=6	tCK(AVG)	1.875	<2.5	1.875	<2.5	ns
Supported CL Settings			5,6,7,8		6,8		nCK
Supported CWL Settings			5,6		5,6		nCK

DDR3-1333MHz

Speed Bin			DDR3-1333				Unit
CL-nRCD-nRP			8-8-8 (-CF)		9-9-9 (-CG)		
Parameter	Symbol		Min	Max	Min	Max	
Internal read command to first data	tAA		12.000	20.000	13.125 (13.125) ^{5,11}	20.000	ns
ACT to internal read or write delay time	tRCD		12.000	-	13.125 (13.125) ^{5,11}	-	ns
PRE command period	tRP		12.000	-	13.125 (13.125) ^{5,11}	-	ns
ACT to ACT or REF command period	tRC		48.000	-	49.125 (49.125) ^{5,11}	-	ns
ACT to PRE command period	tRAS		36.000	9*tREFI	36.000	9*tREFI	ns
CL=5	CWL=5	tCK(AVG)	2.500	3.300	Reserved	Reserved	ns
	CWL=6	tCK(AVG)	Reserved	Reserved	Reserved	Reserved	ns
	CWL=7	tCK(AVG)	Reserved	Reserved	Reserved	Reserved	ns
CL=6	CWL=5	tCK(AVG)	2.500	3.300	2.500	3.300	ns
	CWL=6	tCK(AVG)	Reserved	Reserved	Reserved	Reserved	ns
	CWL=7	tCK(AVG)	Reserved	Reserved	Reserved	Reserved	ns
CL=7	CWL=5	tCK(AVG)	Reserved	Reserved	Reserved	Reserved	ns
	CWL=6	tCK(AVG)	1.875	<2.5	1.875*	<2.5*	ns
	CWL=7	tCK(AVG)	Reserved	Reserved	Reserved	Reserved	ns
CL=8	CWL=5	tCK(AVG)	Reserved	Reserved	Reserved	Reserved	ns
	CWL=6	tCK(AVG)	1.875	<2.5	1.875	<2.5	ns
	CWL=7	tCK(AVG)	1.500	<1.875	Reserved	Reserved	ns
CL=9	CWL=5	tCK(AVG)	Reserved	Reserved	Reserved	Reserved	ns
	CWL=6	tCK(AVG)	Reserved	Reserved	Reserved	Reserved	ns
	CWL=7	tCK(AVG)	1.500	<1.875	1.500	<1.875	ns
CL=10	CWL=5	tCK(AVG)	Reserved	Reserved	Reserved	Reserved	ns
	CWL=6	tCK(AVG)	Reserved	Reserved	Reserved	Reserved	ns
	CWL=7	tCK(AVG)	1.500*	<1.875*	1.500*	<1.875*	ns
Supported CL Settings			5,6,7,8,9		5,6,7,8,9		nCK
Supported CWL Settings			5,6,7		5,6,7		nCK

*: Optional



DDR3-1600MHz

Speed Bin		DDR3-1600		Unit	
CL-nRCD-nRP		11-11-11 (-DI)			
Parameter	Symbol	Min	Max		
Internal read command to first data	tAA	13.75 (13.125) ^{5,11}	20.000	ns	
ACT to internal read or write delay time	tRCD	13.75 (13.125) ^{5,11}	-	ns	
PRE command period	tRP	13.75 (13.125) ^{5,11}	-	ns	
ACT to ACT or REF command period	tRC	48.75 (48.125) ^{5,11}	-	ns	
ACT to PRE command period	tRAS	35.000	9*tREFI	ns	
CL=5	CWL=5	tCK(AVG)	3.000	3.300	ns
	CWL=6	tCK(AVG)	Reserved	Reserved	ns
	CWL=7	tCK(AVG)	Reserved	Reserved	ns
CL=6	CWL=5	tCK(AVG)	2.500	3.300	ns
	CWL=6	tCK(AVG)	Reserved	Reserved	ns
	CWL=7	tCK(AVG)	Reserved	Reserved	ns
CL=7	CWL=5	tCK(AVG)	Reserved	Reserved	ns
	CWL=6	tCK(AVG)	1.875*	<2.5*	ns
	CWL=7	tCK(AVG)	Reserved	Reserved	ns
CL=8	CWL=5	tCK(AVG)	Reserved	Reserved	ns
	CWL=6	tCK(AVG)	1.875	<2.5	ns
	CWL=7	tCK(AVG)	Reserved	Reserved	ns
CL=9	CWL=5	tCK(AVG)	Reserved	Reserved	ns
	CWL=6	tCK(AVG)	Reserved	Reserved	ns
	CWL=7	tCK(AVG)	1.500	<1.875	ns
CL=10	CWL=5	tCK(AVG)	Reserved	Reserved	ns
	CWL=6	tCK(AVG)	Reserved	Reserved	ns
	CWL=7	tCK(AVG)	1.500*	<1.875*	ns
CL=11	CWL=5	tCK(AVG)	Reserved	Reserved	ns
	CWL=6	tCK(AVG)	Reserved	Reserved	ns
	CWL=7	tCK(AVG)	Reserved	Reserved	ns
	CWL=8	tCK(AVG)	1.25*	<1.5*	ns
Supported CL Settings		5, 6,(7),8,(9),10,11		nCK	
Supported CWL Settings		5,6,7,8		nCK	

*: Optional

AC Timing Specifications for DDR3 SDRAM Devices Used on Module (1066MHz)

Parameter	Symbol	DDR3-1066		Units	Notes
		Min.	Max.		
Clock Timing					
Minimum Clock Cycle Time (DLL off mode)	tCK (DLL_OFF)	8	-	ns	
Average Clock Period	tCK(avg)	Refer to "Standard Speed Bins)		ps	
Average high pulse width	tCH(avg)	0.47	0.53	tCK(avg)	
Average low pulse width	tCL(avg)	0.47	0.53	tCK(avg)	
Absolute Clock Period	tCK(abs)	Min.: tCK(avg)min + tJIT(per)min Max.: tCK(avg)max + tJIT(per)max		ps	
Absolute clock HIGH pulse width	tCH(abs)	0.43	-	tCK(avg)	
Absolute clock LOW pulse width	tCL(abs)	0.43	-	tCK(avg)	
Clock Period Jitter	JIT(per)	-90	90	ps	
Clock Period Jitter during DLL locking period	JIT(per, lck)	-80	80	ps	
Cycle to Cycle Period Jitter	tJIT(cc)	180	180	ps	
Cycle to Cycle Period Jitter during DLL locking period	JIT(cc, lck)	160	160	ps	
Duty Cycle Jitter	tJIT(duty)	-	-	ps	
Cumulative error across 2 cycles	tERR(2per)	-132	132	ps	
Cumulative error across 3 cycles	tERR(3per)	-157	157	ps	
Cumulative error across 4 cycles	tERR(4per)	-175	175	ps	
Cumulative error across 5 cycles	tERR(5per)	-188	188	ps	
Cumulative error across 6 cycles	tERR(6per)	-200	200	ps	
Cumulative error across 7 cycles	tERR(7per)	-209	209	ps	
Cumulative error across 8 cycles	tERR(8per)	-217	217	ps	
Cumulative error across 9 cycles	tERR(9per)	-224	224	ps	
Cumulative error across 10 cycles	tERR(10per)	-231	231	ps	
Cumulative error across 11 cycles	tERR(11per)	-237	237	ps	
Cumulative error across 12 cycles	tERR(12per)	-242	242	ps	
Cumulative error across n = 13, 14 . . . 49, 50 cycles	tERR(nper)	tERR(nper)min = (1 + 0.68ln(n)) * tJIT(per)min tERR(nper)max = (1 + 0.68ln(n)) * tJIT(per)max		ps	
Data Timing					
DQS, DQS# to DQ skew, per group, per access	tDQSQ	-	150	ps	
DQ output hold time from DQS, DQS#	tQH	0.38	-	tCK(avg)	
DQ low-impedance time from CK, CK#	tLZ(DQ)	-600	300	ps	
DQ high impedance time from CK, CK#	tHZ(DQ)	-	300	ps	
Data setup time to DQS, DQS# referenced to Vih(ac) / Vil(ac) levels	tDS(base) AC175	25		ps	
Data setup time to DQS, DQS# referenced to Vih(ac) / Vil(ac) levels	tDS(base) AC150	75		ps	
Data hold time from DQS, DQS# referenced to Vih(dc) / Vil(dc) levels	tDH(base) DC100	100		ps	
DQ and DM Input pulse width for each input	tDIPW	490		ps	
Data Strobe Timing					
DQS, DQS# differential READ Preamble	tRPRE	0.9	Note 19	tCK(avg)	
DQS, DQS# differential READ Postamble	tRPST	0.3	Note 11	tCK(avg)	
DQS, DQS# differential output high time	tQSH	0.38	-	tCK(avg)	
DQS, DQS# differential output low time	tQSL	0.38	-	tCK(avg)	
DQS, DQS# differential WRITE Preamble	tWPRE	0.9	-	tCK(avg)	
DQS, DQS# differential WRITE Postamble	tWPST	0.3	-	tCK(avg)	
DQS, DQS# rising edge output access time from rising CK, CK#	tDQSCK	-300	300	tCK(avg)	
DQS and DQS# low-impedance time (Referenced from RL - 1)	tLZ(DQS)	-600	300	tCK(avg)	
DQS and DQS# high-impedance time (Referenced from RL + BL/2)	tHZ(DQS)	-	300	tCK(avg)	
DQS, DQS# differential input low pulse width	tDQSL	0.45	0.55	tCK(avg)	
DQS, DQS# differential input high pulse width	tDQSH	0.45	0.55	tCK(avg)	
DQS, DQS# rising edge to CK, CK# rising edge	tDQSS	-0.25	0.25	tCK(avg)	
DQS, DQS# falling edge setup time to CK, CK# rising edge	tDSS	0.2	-	tCK(avg)	
DQS, DQS# falling edge hold time from CK, CK# rising edge	tDSH	0.2	-	tCK(avg)	
Command and Address Timing					
DLL locking time	tDLLK	512	-	nCK	

M2S1G64CBH4B5P / M2S2G64CB88B5N / M2S4G64CB8HB5N
1GB: 128M x 64 / 2GB: 256M x 64 / 4GB: 512M x 64
PC3-8500 / PC3-10600 / PC3-12800
Unbuffered DDR3 SO-DIMM



Internal READ Command to PRECHARGE Command delay	tRTP	tRTPmin.: max(4nCK, 7.5ns) tRTPmax.: -		
Delay from start of internal write transaction to internal read command	tWTR	tWTRmin.: max(4nCK, 7.5ns) tWTRmax.:		
WRITE recovery time	tWR	15	-	ns
Mode Register Set command cycle time	tMRD	4	-	nCK
Mode Register Set command update delay	tMOD	tMODmin.: max(12nCK, 15ns) tMODmax.:		
ACT to internal read or write delay time	tRCD			
PRE command period	tRP			
ACT to ACT or REF command period	tRC			
CAS# to CAS# command delay	tCCD	4	-	nCK
Auto precharge write recovery + precharge time	tDAL(min)	WR + roundup(tRP / tCK(avg))		nCK
Multi-Purpose Register Recovery Time	tMPRR	1	-	nCK
ACTIVE to PRECHARGE command period	tRAS	Standard Speed Bins		
ACTIVE to ACTIVE command period for 1KB page size	tRRD	max(4nCK, 7.5ns)	-	
ACTIVE to ACTIVE command period for 2KB page size	tRRD	tRRDmin.: max(4nCK, 10ns) tRRDmax.:		
Four activate window for 1KB page size	tFAW	37.5	-	ns
Four activate window for 2KB page size	tFAW	50	-	ns
Command and Address setup time to CK, CK# referenced to Vih(ac) / Vil(ac) levels	tIS(base)	125	-	ps
Command and Address hold time from CK, CK# referenced to Vih(dc) / Vil(dc) levels	tIH(base)	200	-	ps
Command and Address setup time to CK, CK# referenced to Vih(ac) / Vil(ac) levels	tIS(base) AC150	125+150	-	ps
Control and Address Input pulse width for each input	tIPW	780	-	ps
Calibration Timing				
Power-up and RESET calibration time	tZQinit	512	-	nCK
Normal operation Full calibration time	tZQoper	256	-	nCK
Normal operation Short calibration time	tZQCS	64	-	nCK
Reset Timing				
Exit Reset from CKE HIGH to a valid command	tXPR	tXPRmin.: max(5nCK, tRFC(min) + 10ns) tXPRmax.: -		
Self Refresh Timings				
Exit Self Refresh to commands not requiring a locked DLL	tXS	tXSmin.: max(5nCK, tRFC(min) + 10ns) tXSmax.: -		
Exit Self Refresh to commands requiring a locked DLL	tXSDLL	tXSDLLmin.: tDLLK(min) tXSDLLmax.: -	nCK	
Minimum CKE low width for Self Refresh entry to exit timing	tCKESR	tCKESRmin.: tCKE(min) + 1 nCK tCKESRmax.: -		
Valid Clock Requirement after Self Refresh Entry (SRE) or Power-Down Entry (PDE)	tCKSRE	tCKSREmin.: max(5 nCK, 10 ns) tCKSREmax.: -		
Valid Clock Requirement before Self Refresh Exit (SRX) or Power-Down Exit (PDX) or Reset Exit	tCKSRX	tCKSRXmin.: max(5 nCK, 10 ns) tCKSRXmax.: -		
Power Down Timings				
Exit Power Down with DLL on to any valid command; Exit Precharge Power Down with DLL frozen to commands not requiring a locked DLL	tXP	tXPmin.: max(3nCK, 7.5ns) tXPmax.: -		
Exit Precharge Power Down with DLL frozen to commands requiring a locked DLL	tXPDLL	tXPDLLmin.: max(10nCK, 24ns) tXPDLLmax.: -		
CKE minimum pulse width	tCKE	tCKEmin.: max(3nCK 5.625ns) tCKEmax.: -		
Command pass disable delay	tCPDED	tCPDEDmin.: 1 tCPDEDmin.: -	nCK	
Power Down Entry to Exit Timing	tPD	tPDmin.: tCKE(min) tPDmax.: 9*tREFI		
Timing of ACT command to Power Down entry	tACTPDEN	tACTPDENmin.: 1 tACTPDENmax.: -	nCK	
Timing of PRE or PREA command to Power Down entry	tPRPDEN	tPRPDENmin.: 1 tPRPDENmax.: -	nCK	
Timing of RD/RDA command to Power Down entry	tRDPDEN	tRDPDENmin.: RL+4+1 tRDPDENmax.: -	nCK	

M2S1G64CBH4B5P / M2S2G64CB88B5N / M2S4G64CB8HB5N
1GB: 128M x 64 / 2GB: 256M x 64 / 4GB: 512M x 64
PC3-8500 / PC3-10600 / PC3-12800
Unbuffered DDR3 SO-DIMM



Timing of WR command to Power Down entry (BL8OTF, BL8MRS, BC4OTF)	tWRPDEN	tWRPDENmin.: WL + 4 + (tWR / tCK(avg)) tWRPDENmax.: -		nCK	
Timing of WRA command to Power Down entry (BL8OTF, BL8MRS, BC4OTF)	tWRAPDEN	tWRAPDENmin.: WL+4+WR+1 tWRAPDENmax.: -		nCK	
Timing of WR command to Power Down entry (BC4MRS)	tWRPDEN	tWRPDENmin.: WL + 2 + (tWR / tCK(avg)) tWRPDENmax.: -		nCK	
Timing of WRA command to Power Down entry (BC4MRS)	tWRAPDEN	tWRAPDENmin.: WL + 2 +WR + 1 tWRAPDENmax.: -		nCK	
Timing of REF command to Power Down entry	tREFPDEN	tREFPDENmin.: 1 tREFPDENmax.: -		nCK	
Timing of MRS command to Power Down entry	tMRSPDEN	tMRSPDENmin.: tMOD(min) tMRSPDENmax.: -			
ODT Timings					
ODT high time without write command or with write command and BC4	ODTH4	ODTH4min.: 4 ODTH4max.: -		nCK	
ODT high time with Write command and BL8	ODTH8	ODTH8min.: 6 ODTH8max.: -		nCK	
Asynchronous RTT turn-on delay (Power-Down with DLL frozen)	tAONPD	2	8.5	ns	
Asynchronous RTT turn-off delay (Power-Down with DLL frozen)	tAOFPD	2	8.5	ns	
RTT turn-on	tAON	-300	300	ps	
RTT_Nom and RTT_WR turn-off time from ODTLoff reference	tAOF	0.3	0.7	tCK(avg)	
RTT dynamic change skew	tADC	0.3	0.7	tCK(avg)	
Write Leveling Timings					
First DQS/DQS# rising edge after write leveling mode is programmed	tWLMRD	40	-	nCK	
DQS/DQS# delay after write leveling mode is programmed	tWLDQSEN	25	-	nCK	
Write leveling setup time from rising CK, CK# crossing to rising DQS, DQS# crossing	tWLS	245	-	ps	
Write leveling hold time from rising DQS, DQS# crossing to rising CK, CK# crossing	tWLH	245	-	ps	
Write leveling output delay	tWLO	0	9	ns	
Write leveling output error	tWLOE	0	2	ns	



AC Timing Specifications for DDR3 SDRAM Devices Used on Module (1333MHz)

Parameter	Symbol	DDR3-1333		Units	Notes
		Min.	Max.		
Clock Timing					
Minimum Clock Cycle Time (DLL off mode)	tCK (DLL_OFF)	8	-	ns	
Average Clock Period	tCK(avg)	Refer to "Standard Speed Bins)		ps	
Average high pulse width	tCH(avg)	0.47	0.53	tCK(avg)	
Average low pulse width	tCL(avg)	0.47	0.53	tCK(avg)	
Absolute Clock Period	tCK(abs)	Min.: tCK(avg)min + tJIT(per)min Max.: tCK(avg)max + tJIT(per)max		ps	
Absolute clock HIGH pulse width	tCH(abs)	0.43	-	tCK(avg)	
Absolute clock LOW pulse width	tCL(abs)	0.43	-	tCK(avg)	
Clock Period Jitter	JIT(per)	-80	80	ps	
Clock Period Jitter during DLL locking period	JIT(per, lck)	-70	70	ps	
Cycle to Cycle Period Jitter	tJIT(cc)	160	160	ps	
Cycle to Cycle Period Jitter during DLL locking period	JIT(cc, lck)	140	140	ps	
Duty Cycle Jitter	tJIT(duty)	-	-	ps	
Cumulative error across 2 cycles	tERR(2per)	-118	118	ps	
Cumulative error across 3 cycles	tERR(3per)	-140	140	ps	
Cumulative error across 4 cycles	tERR(4per)	-155	155	ps	
Cumulative error across 5 cycles	tERR(5per)	-168	168	ps	
Cumulative error across 6 cycles	tERR(6per)	-177	177	ps	
Cumulative error across 7 cycles	tERR(7per)	-186	186	ps	
Cumulative error across 8 cycles	tERR(8per)	-193	193	ps	
Cumulative error across 9 cycles	tERR(9per)	-200	200	ps	
Cumulative error across 10 cycles	tERR(10per)	-205	205	ps	
Cumulative error across 11 cycles	tERR(11per)	-210	210	ps	
Cumulative error across 12 cycles	tERR(12per)	-215	215	ps	
Cumulative error across n = 13, 14 . . . 49, 50 cycles	tERR(nper)	tERR(nper)min = (1 + 0.68ln(n)) * tJIT(per)min tERR(nper)max = (1 + 0.68ln(n)) * tJIT(per)max		ps	
Data Timing					
DQS, DQS# to DQ skew, per group, per access	tDQSQ	-	125	ps	
DQ output hold time from DQS, DQS#	tQH	0.38	-	tCK(avg)	
DQ low-impedance time from CK, CK#	tLZ(DQ)	-500	250	ps	
DQ high impedance time from CK, CK#	tHZ(DQ)	-	250	ps	
Data setup time to DQS, DQS# referenced to Vih(ac) / Vil(ac) levels	tDS(base) AC175	-		ps	
Data setup time to DQS, DQS# referenced to Vih(ac) / Vil(ac) levels	tDS(base) AC150	30		ps	
Data hold time from DQS, DQS# referenced to Vih(dc) / Vil(dc) levels	tDH(base) DC100	65		ps	
DQ and DM Input pulse width for each input	tDIPW	400	-	ps	
Data Strobe Timing					
DQS,DQS# differential READ Preamble	tRPRE	0.9	Note 19	tCK(avg)	
DQS, DQS# differential READ Postamble	tRPST	0.3	Note 11	tCK(avg)	
DQS, DQS# differential output high time	tQSH	0.4	-	tCK(avg)	
DQS, DQS# differential output low time	tQSL	0.4	-	tCK(avg)	
DQS, DQS# differential WRITE Preamble	tWPRE	0.9	-	tCK(avg)	
DQS, DQS# differential WRITE Postamble	tWPST	0.3	-	tCK(avg)	
DQS, DQS# rising edge output access time from rising CK, CK#	tDQSCK	-255	255	tCK(avg)	
DQS and DQS# low-impedance time (Referenced from RL - 1)	tLZ(DQS)	-500	250	tCK(avg)	
DQS and DQS# high-impedance time (Referenced from RL + BL/2)	tHZ(DQS)	-	250	tCK(avg)	
DQS, DQS# differential input low pulse width	tDQSL	0.45	0.55	tCK(avg)	
DQS, DQS# differential input high pulse width	tDQSH	0.45	0.55	tCK(avg)	
DQS, DQS# rising edge to CK, CK# rising edge	tDQSS	-0.25	0.25	tCK(avg)	
DQS, DQS# falling edge setup time to CK, CK# rising edge	tDSS	0.2	-	tCK(avg)	
DQS, DQS# falling edge hold time from CK, CK# rising edge	tDSH	0.2	-	tCK(avg)	
Command and Address Timing					
DLL locking time	tDLLK	512	-	nCK	

M2S1G64CBH4B5P / M2S2G64CB88B5N / M2S4G64CB8HB5N
1GB: 128M x 64 / 2GB: 256M x 64 / 4GB: 512M x 64
PC3-8500 / PC3-10600 / PC3-12800
Unbuffered DDR3 SO-DIMM



Internal READ Command to PRECHARGE Command delay	tRTP	tRTPmin.: max(4nCK, 7.5ns) tRTPmax.: -			
Delay from start of internal write transaction to internal read command	tWTR	tWTRmin.: max(4nCK, 7.5ns) tWTRmax.:			
WRITE recovery time	tWR	15	-	ns	
Mode Register Set command cycle time	tMRD	4	-	nCK	
Mode Register Set command update delay	tMOD	tMODmin.: max(12nCK, 15ns) tMODmax.:			
ACT to internal read or write delay time	tRCD				
PRE command period	tRP				
ACT to ACT or REF command period	tRC				
CAS# to CAS# command delay	tCCD	4		nCK	
Auto precharge write recovery + precharge time	tDAL(min)	WR + roundup(tRP / tCK(avg))		nCK	
Multi-Purpose Register Recovery Time	tMPRR	1	-	nCK	
ACTIVE to PRECHARGE command period	tRAS	Standard Speed Bins			
ACTIVE to ACTIVE command period for 1KB page size	tRRD	tRRDmin.: max(4nCK, 6ns) tRRDmax.:			
ACTIVE to ACTIVE command period for 2KB page size	tRRD	tRRDmin.: max(4nCK, 7.5ns) tRRDmax.:			
Four activate window for 1KB page size	tFAW	30	0	ns	
Four activate window for 2KB page size	tFAW	45	0	ns	
Command and Address setup time to CK, CK# referenced to Vih(ac) / Vil(ac) levels	tIS(base)	65	-	ps	
Command and Address hold time from CK, CK# referenced to Vih(dc) / Vil(dc) levels	tIH(base)	140	-	ps	
Command and Address setup time to CK, CK# referenced to Vih(ac) / Vil(ac) levels	tIS(base) AC150	65+125	-	ps	
Control and Address Input pulse width for each input	tIPW	620	-	ps	
Calibration Timing					
Power-up and RESET calibration time	tZQinit	512	-	nCK	
Normal operation Full calibration time	tZQoper	256	-	nCK	
Normal operation Short calibration time	tZQCS	64	-	nCK	
Reset Timing					
Exit Reset from CKE HIGH to a valid command	tXPR	tXPRmin.: max(5nCK, tRFC(min) + 10ns) tXPRmax.: -			
Self Refresh Timings					
Exit Self Refresh to commands not requiring a locked DLL	tXS	tXSmin.: max(5nCK, tRFC(min) + 10ns) tXSmax.: -			
Exit Self Refresh to commands requiring a locked DLL	tXSDLL	tXSDLLmin.: tDLLK(min) tXSDLLmax.: -		nCK	
Minimum CKE low width for Self Refresh entry to exit timing	tCKESR	tCKESRmin.: tCKE(min) + 1 nCK tCKESRmax.: -			
Valid Clock Requirement after Self Refresh Entry (SRE) or Power-Down Entry (PDE)	tCKSRE	tCKSREmin.: max(5 nCK, 10 ns) tCKSREmax.: -			
Valid Clock Requirement before Self Refresh Exit (SRX) or Power-Down Exit (PDX) or Reset Exit	tCKSRX	tCKSRXmin.: max(5 nCK, 10 ns) tCKSRXmax.: -			
Power Down Timings					
Exit Power Down with DLL on to any valid command; Exit Precharge Power Down with DLL frozen to commands not requiring a locked DLL	tXP	tXPmin.: max(3nCK, 6ns) tXPmax.: -			
Exit Precharge Power Down with DLL frozen to commands requiring a locked DLL	tXPDLL	tXPDLLmin.: max(10nCK, 24ns) tXPDLLmax.: -			
CKE minimum pulse width	tCKE	tCKEmin.: max(3nCK, 5.625ns) tCKEmax.: -			
Command pass disable delay	tCPDED	tCPDEDmin.: 1 tCPDEDmax.: -		nCK	
Power Down Entry to Exit Timing	tPD	tPDmin.: tCKE(min) tPDmax.: 9*tREFI			
Timing of ACT command to Power Down entry	tACTPDEN	tACTPDENmin.: 1 tACTPDENmax.: -		nCK	
Timing of PRE or PREA command to Power Down entry	tPRPDEN	tPRPDENmin.: 1 tPRPDENmax.: -		nCK	

M2S1G64CBH4B5P / M2S2G64CB88B5N / M2S4G64CB8HB5N
1GB: 128M x 64 / 2GB: 256M x 64 / 4GB: 512M x 64
PC3-8500 / PC3-10600 / PC3-12800
Unbuffered DDR3 SO-DIMM



Timing of RD/RDA command to Power Down entry	tRDPDEN	tRDPDENmin.: RL+4+1 tRDPDENmax.: -		nCK	
Timing of WR command to Power Down entry (BL8OTF, BL8MRS, BC4OTF)	tWRPDEN	tWRPDENmin.: WL + 4 + (tWR / tCK(avg)) tWRPDENmax.: -		nCK	
Timing of WRA command to Power Down entry (BL8OTF, BL8MRS, BC4OTF)	tWRAPDEN	tWRAPDENmin.: WL+4+WR+1 tWRAPDENmax.: -		nCK	
Timing of WR command to Power Down entry (BC4MRS)	tWRPDEN	tWRPDENmin.: WL + 2 + (tWR / tCK(avg)) tWRPDENmax.: -		nCK	
Timing of WRA command to Power Down entry (BC4MRS)	tWRAPDEN	tWRAPDENmin.: WL + 2 + WR + 1 tWRAPDENmax.: -		nCK	
Timing of REF command to Power Down entry	tREFPDEN	tREFPDENmin.: 1 tREFPDENmax.: -		nCK	
Timing of MRS command to Power Down entry	tMRSPDEN	tMRSPDENmin.: tMOD(min) tMRSPDENmax.: -			
ODT Timings					
ODT high time without write command or with write command and BC4	ODTH4	ODTH4min.: 4 ODTH4max.: -		nCK	
ODT high time with Write command and BL8	ODTH8	ODTH8min.: 6 ODTH8max.: -		nCK	
Asynchronous RTT turn-on delay (Power-Down with DLL frozen)	tAONPD	2	8.5	ns	
Asynchronous RTT turn-off delay (Power-Down with DLL frozen)	tAOFPD	2	8.5	ns	
RTT turn-on	tAON	-250	250	ps	
RTT_Nom and RTT_WR turn-off time from ODTLoff reference	tAOF	0.3	0.7	tCK(avg)	
RTT dynamic change skew	tADC	0.3	0.7	tCK(avg)	
Write Leveling Timings					
First DQS/DQS# rising edge after write leveling mode is programmed	tWLMRD	40	-	nCK	
DQS/DQS# delay after write leveling mode is programmed	tWLDQSEN	25	-	nCK	
Write leveling setup time from rising CK, CK# crossing to rising DQS, DQS# crossing	tWLS	195	-	ps	
Write leveling hold time from rising DQS, DQS# crossing to rising CK, CK# crossing	tWLH	195	-	ps	
Write leveling output delay	tWLO	0	9	ns	
Write leveling output error	tWLOE	0	2	ns	



AC Timing Specifications for DDR3 SDRAM Devices Used on Module (1600MHz)

Parameter	Symbol	DDR3-1600		Units	Notes
		Min.	Max.		
Clock Timing					
Minimum Clock Cycle Time (DLL off mode)	tCK (DLL_OFF)	8	-	ns	
Average Clock Period	tCK(avg)	Refer to "Standard Speed Bins)		ps	
Average high pulse width	tCH(avg)	0.47	0.53	tCK(avg)	
Average low pulse width	tCL(avg)	0.47	0.53	tCK(avg)	
Absolute Clock Period	tCK(abs)	Min.: tCK(avg)min + tJIT(per)min Max.: tCK(avg)max + tJIT(per)max		ps	
Absolute clock HIGH pulse width	tCH(abs)	0.43	-	tCK(avg)	
Absolute clock LOW pulse width	tCL(abs)	0.43	-	tCK(avg)	
Clock Period Jitter	JIT(per)	-70	70	ps	
Clock Period Jitter during DLL locking period	JIT(per, lck)	-60	60	ps	
Cycle to Cycle Period Jitter	tJIT(cc)	140	140	ps	
Cycle to Cycle Period Jitter during DLL locking period	JIT(cc, lck)	120	120	ps	
Duty Cycle Jitter	tJIT(duty)	-	-	ps	
Cumulative error across 2 cycles	tERR(2per)	-103	103	ps	
Cumulative error across 3 cycles	tERR(3per)	-122	122	ps	
Cumulative error across 4 cycles	tERR(4per)	-136	136	ps	
Cumulative error across 5 cycles	tERR(5per)	-147	147	ps	
Cumulative error across 6 cycles	tERR(6per)	-155	155	ps	
Cumulative error across 7 cycles	tERR(7per)	-163	163	ps	
Cumulative error across 8 cycles	tERR(8per)	-169	169	ps	
Cumulative error across 9 cycles	tERR(9per)	-175	175	ps	
Cumulative error across 10 cycles	tERR(10per)	-180	180	ps	
Cumulative error across 11 cycles	tERR(11per)	-184	184	ps	
Cumulative error across 12 cycles	tERR(12per)	-188	188	ps	
Cumulative error across n = 13, 14 . . . 49, 50 cycles	tERR(nper)	tERR(nper)min = (1 + 0.68ln(n)) * tJIT(per)min tERR(nper)max = (1 + 0.68ln(n)) * tJIT(per)max		ps	
Data Timing					
DQS, DQS# to DQ skew, per group, per access	tDQSQ	-	100	ps	
DQ output hold time from DQS, DQS#	tQH	0.38	-	tCK(avg)	
DQ low-impedance time from CK, CK#	tLZ(DQ)	-450	225	ps	
DQ high impedance time from CK, CK#	tHZ(DQ)	-	225	ps	
Data setup time to DQS, DQS# referenced to Vih(ac) / Vil(ac) levels	tDS(base) AC175	-		ps	
Data setup time to DQS, DQS# referenced to Vih(ac) / Vil(ac) levels	tDS(base) AC150	10		ps	
Data hold time from DQS, DQS# referenced to Vih(dc) / Vil(dc) levels	tDH(base) DC100	45		ps	
DQ and DM Input pulse width for each input	tDIPW	360	-	ps	
Data Strobe Timing					
DQS, DQS# differential READ Preamble	tRPRE	0.9	Note 19	tCK(avg)	
DQS, DQS# differential READ Postamble	tRPST	0.3	Note 11	tCK(avg)	
DQS, DQS# differential output high time	tQSH	0.4	-	tCK(avg)	
DQS, DQS# differential output low time	tQSL	0.4	-	tCK(avg)	
DQS, DQS# differential WRITE Preamble	tWPRE	0.9	-	tCK(avg)	
DQS, DQS# differential WRITE Postamble	tWPST	0.3	-	tCK(avg)	
DQS, DQS# rising edge output access time from rising CK, CK#	tDQSCK	-255	255	tCK(avg)	
DQS and DQS# low-impedance time (Referenced from RL - 1)	tLZ(DQS)	-450	225	tCK(avg)	
DQS and DQS# high-impedance time (Referenced from RL + BL/2)	tHZ(DQS)	-	225	tCK(avg)	
DQS, DQS# differential input low pulse width	tDQSL	0.45	0.55	tCK(avg)	
DQS, DQS# differential input high pulse width	tDQSH	0.45	0.55	tCK(avg)	
DQS, DQS# rising edge to CK, CK# rising edge	tDQSS	-0.27	0.27	tCK(avg)	
DQS, DQS# falling edge setup time to CK, CK# rising edge	tDSS	0.18	-	tCK(avg)	
DQS, DQS# falling edge hold time from CK, CK# rising edge	tDSH	0.18	-	tCK(avg)	
Command and Address Timing					
DLL locking time	tDLLK	512	-	nCK	

M2S1G64CBH4B5P / M2S2G64CB88B5N / M2S4G64CB8HB5N
1GB: 128M x 64 / 2GB: 256M x 64 / 4GB: 512M x 64
PC3-8500 / PC3-10600 / PC3-12800
Unbuffered DDR3 SO-DIMM



Internal READ Command to PRECHARGE Command delay	tRTP	tRTPmin.: max(4nCK, 7.5ns) tRTPmax.: -		
Delay from start of internal write transaction to internal read command	tWTR	tWTRmin.: max(4nCK, 7.5ns) tWTRmax.:		
WRITE recovery time	tWR	15	-	ns
Mode Register Set command cycle time	tMRD	4	-	nCK
Mode Register Set command update delay	tMOD	tMODmin.: max(12nCK, 15ns) tMODmax.:		
ACT to internal read or write delay time	tRCD			
PRE command period	tRP			
ACT to ACT or REF command period	tRC			
CAS# to CAS# command delay	tCCD	4		nCK
Auto precharge write recovery + precharge time	tDAL(min)	WR + roundup(tRP / tCK(avg))		nCK
Multi-Purpose Register Recovery Time	tMPRR	1	-	nCK
ACTIVE to PRECHARGE command period	tRAS	Standard Speed Bins		
ACTIVE to ACTIVE command period for 1KB page size	tRRD	tRRDmin.: max(4nCK, 6ns) tRRDmax.:		
ACTIVE to ACTIVE command period for 2KB page size	tRRD	tRRDmin.: max(4nCK, 7.5ns) tRRDmax.:		
Four activate window for 1KB page size	tFAW	30	-	ns
Four activate window for 2KB page size	tFAW	40	-	ns
Command and Address setup time to CK, CK# referenced to Vih(ac) / Vil(ac) levels	tIS(base)	45	-	ps
Command and Address hold time from CK, CK# referenced to Vih(dc) / Vil(dc) levels	tIH(base)	120	-	ps
Command and Address setup time to CK, CK# referenced to Vih(ac) / Vil(ac) levels	tIS(base) AC150	170	-	ps
Control and Address Input pulse width for each input	tIPW	560	-	ps
Calibration Timing				
Power-up and RESET calibration time	tZQinit	512	-	nCK
Normal operation Full calibration time	tZQoper	256	-	nCK
Normal operation Short calibration time	tZQCS	64	-	nCK
Reset Timing				
Exit Reset from CKE HIGH to a valid command	tXPR	tXPRmin.: max(5nCK, tRFC(min) + 10ns) tXPRmax.: -		
Self Refresh Timings				
Exit Self Refresh to commands not requiring a locked DLL	tXS	tXSmin.: max(5nCK, tRFC(min) + 10ns) tXSmax.: -		
Exit Self Refresh to commands requiring a locked DLL	tXSDLL	tXSDLLmin.: tDLLK(min) tXSDLLmax.: -	nCK	
Minimum CKE low width for Self Refresh entry to exit timing	tCKESR	tCKESRmin.: tCKE(min) + 1 nCK tCKESRmax.: -		
Valid Clock Requirement after Self Refresh Entry (SRE) or Power-Down Entry (PDE)	tCKSRE	tCKSREmin.: max(5 nCK, 10 ns) tCKSREmax.: -		
Valid Clock Requirement before Self Refresh Exit (SRX) or Power-Down Exit (PDX) or Reset Exit	tCKSRX	tCKSRXmin.: max(5 nCK, 10 ns) tCKSRXmax.: -		
Power Down Timings				
Exit Power Down with DLL on to any valid command; Exit Precharge Power Down with DLL frozen to commands not requiring a locked DLL	tXP	tXPmin.: max(3nCK, 6ns) tXPmax.: -		
Exit Precharge Power Down with DLL frozen to commands requiring a locked DLL	tXPDLL	tXPDLLmin.: max(10nCK, 24ns) tXPDLLmax.: -		
CKE minimum pulse width	tCKE	tCKEmin.: max(3nCK, 5ns) tCKEmax.: -		
Command pass disable delay	tCPDED	tCPDEDmin.: 1 tCPDEDmax.: -	nCK	
Power Down Entry to Exit Timing	tPD	tPDmin.: tCKE(min) tPDmax.: 9*tREFI		
Timing of ACT command to Power Down entry	tACTPDEN	tACTPDENmin.: 1 tACTPDENmax.: -	nCK	
Timing of PRE or PREA command to Power Down entry	tPRPDEN	tPRPDENmin.: 1 tPRPDENmax.: -	nCK	

M2S1G64CBH4B5P / M2S2G64CB88B5N / M2S4G64CB8HB5N
1GB: 128M x 64 / 2GB: 256M x 64 / 4GB: 512M x 64
PC3-8500 / PC3-10600 / PC3-12800
Unbuffered DDR3 SO-DIMM



Timing of RD/RDA command to Power Down entry	tRDPDEN	tRDPDENmin.: RL+4+1 tRDPDENmax.: -		nCK	
Timing of WR command to Power Down entry (BL8OTF, BL8MRS, BC4OTF)	tWRPDEN	tWRPDENmin.: WL + 4 + (tWR / tCK(avg)) tWRPDENmax.: -		nCK	
Timing of WRA command to Power Down entry (BL8OTF, BL8MRS, BC4OTF)	tWRAPDEN	tWRAPDENmin.: WL+4+WR+1 tWRAPDENmax.: -		nCK	
Timing of WR command to Power Down entry (BC4MRS)	tWRPDEN	tWRPDENmin.: WL + 2 + (tWR / tCK(avg)) tWRPDENmax.: -		nCK	
Timing of WRA command to Power Down entry (BC4MRS)	tWRAPDEN	tWRAPDENmin.: WL + 2 + WR + 1 tWRAPDENmax.: -		nCK	
Timing of REF command to Power Down entry	tREFPDEN	tREFPDENmin.: 1 tREFPDENmax.: -		nCK	
Timing of MRS command to Power Down entry	tMRSPDEN	tMRSPDENmin.: tMOD(min) tMRSPDENmax.: -			
ODT Timings					
ODT high time without write command or with write command and BC4	ODTH4	ODTH4min.: 4 ODTH4max.: -		nCK	
ODT high time with Write command and BL8	ODTH8	ODTH8min.: 6 ODTH8max.: -		nCK	
Asynchronous RTT turn-on delay (Power-Down with DLL frozen)	tAONPD	2	8.5	ns	
Asynchronous RTT turn-off delay (Power-Down with DLL frozen)	tAOFPD	2	8.5	ns	
RTT turn-on	tAON	-225	225	ps	
RTT_Nom and RTT_WR turn-off time from ODTLoff reference	tAOF	0.3	0.7	tCK(avg)	
RTT dynamic change skew	tADC	0.3	0.7	tCK(avg)	
Write Leveling Timings					
First DQS/DQS# rising edge after write leveling mode is programmed	tWLMRD	40	-	nCK	
DQS/DQS# delay after write leveling mode is programmed	tWLDQSEN	25	-	nCK	
Write leveling setup time from rising CK, CK# crossing to rising DQS, DQS# crossing	tWLS	165	-	ps	
Write leveling hold time from rising DQS, DQS# crossing to rising CK, CK# crossing	tWLH	165	-	ps	
Write leveling output delay	tWLO	0	7.5	ns	
Write leveling output error	tWLOE	0	2	ns	

Package Dimensions

[1GB – 1 Rank, 128Mx16 DDR3 SDRAMs]

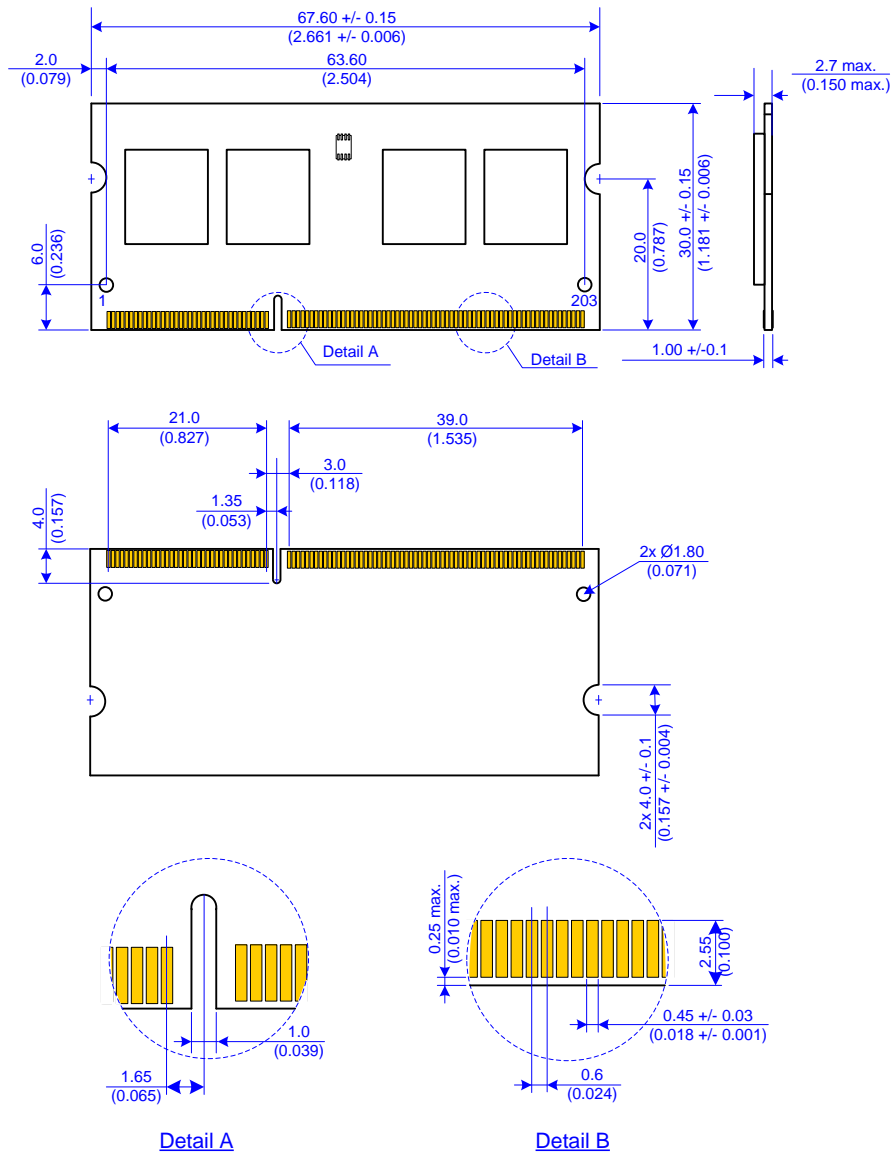

Units: Millimeters (Inches)

Note: Device position and scale are only for reference.

M2S1G64CBH4B5P / M2S2G64CB88B5N / M2S4G64CB8HB5N
1GB: 128M x 64 / 2GB: 256M x 64 / 4GB: 512M x 64
PC3-8500 / PC3-10600 / PC3-12800
Unbuffered DDR3 SO-DIMM



Package Dimensions

[2GB – 1 Rank, 256Mx8 DDR3 SDRAMs]

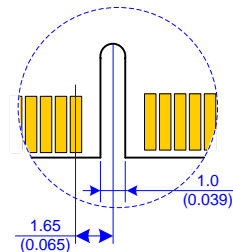
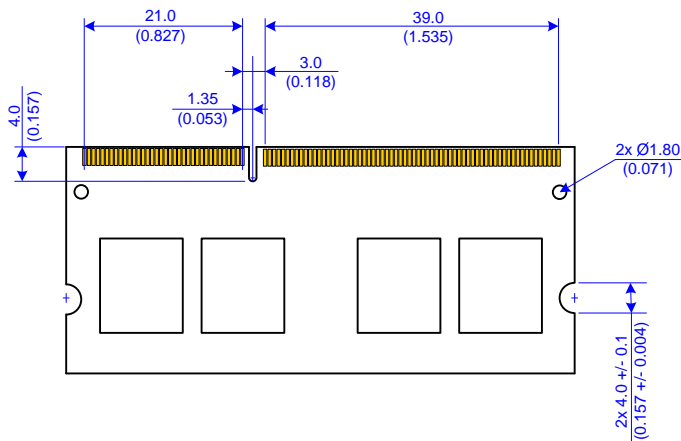
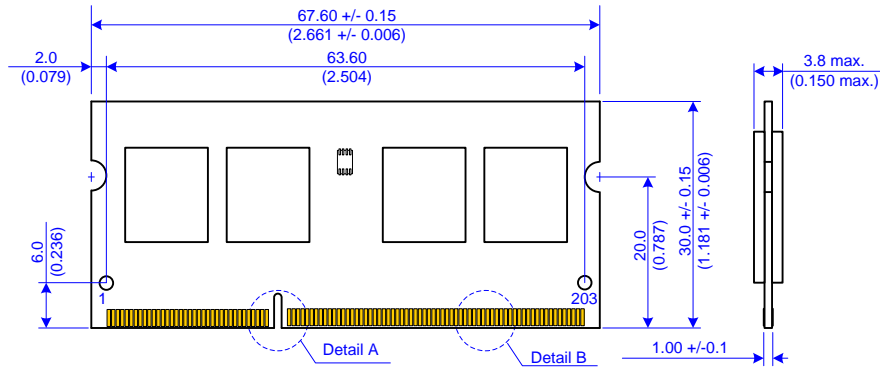

Detail A

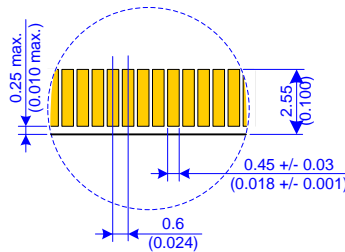

Detail B

Units: Millimeters (Inches)

Note: Device position and scale are only for reference.

M2S1G64CBH4B5P / M2S2G64CB88B5N / M2S4G64CB8HB5N
1GB: 128M x 64 / 2GB: 256M x 64 / 4GB: 512M x 64
PC3-8500 / PC3-10600 / PC3-12800
Unbuffered DDR3 SO-DIMM



Package Dimensions

[4GB – 2 Ranks, 256Mx8 DDR3 SDRAMs]

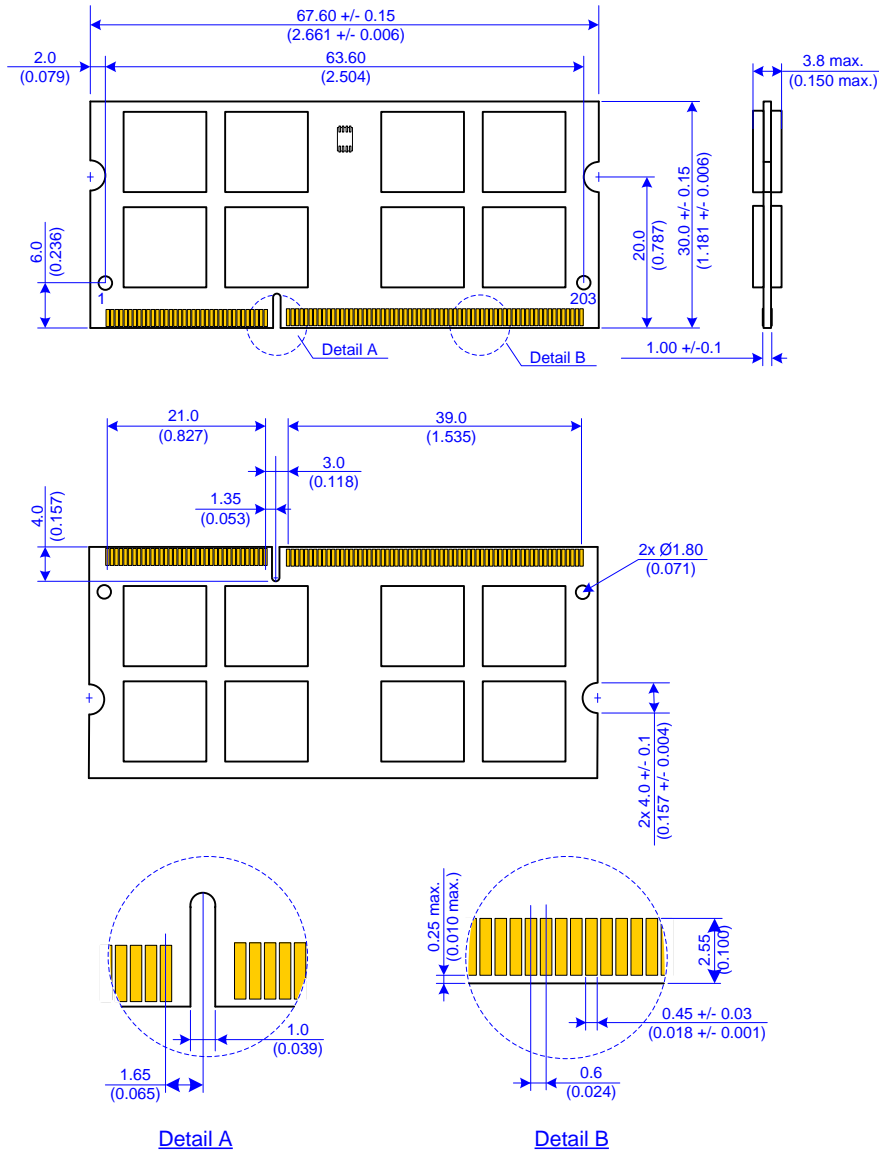

Units: Millimeters (Inches)

Note: Device position and scale are only for reference.

M2S1G64CBH4B5P / M2S2G64CB88B5N / M2S4G64CB8HB5N
1GB: 128M x 64 / 2GB: 256M x 64 / 4GB: 512M x 64
PC3-8500 / PC3-10600 / PC3-12800
Unbuffered DDR3 SO-DIMM



Revision Log

Rev	Date	Modification
0.1	01/2010	Preliminary Release
0.5	05/2010	Preliminary Release 2
1.0	05/2010	Official Release
1.1	07/2010	Version Updated, added 1GB product.
1.2	09/2010	Version Updated, added 1600MHz product and CL=5 Spec.

Nanya Technology Corporation

Hwa Ya Technology Park 669

Fu Hsing 3rd Rd., Kueishan,

Taoyuan, 333, Taiwan, R.O.C.

Tel: +886-3-328-1688

Please visit our home page for more information: www.elixir-memory.com

Printed in Taiwan

©2010